

49 Life Sciences Parkway • Steinbach, MB R5G 2G7
 Phone: 1-800-775-0018 • (204) 320-1801
 Fax: (204) 346-1450
 Email: info@urbanpark.com
 Visit Us At: www.urbanpark.com

urban park

SPECIFICATION SHEET

Belle Isle Series Bench with Back

OPTION 'A' (Length)

- 4'-0"
- 6'-0"

OPTION 'B' (Mounting)

- Embedded
- Surface Mount

OPTION 'C' (Seat Pan)

See Attached Page

OPTION 'D' (Armrest)

- With Arm
- Without Arm

OPTION 'E' (Finish)

- Galvanized
- Powder Coat (includes Autophoretic Coating)
- Stainless Steel # 4 Polish

General Notes:

- 1.) Customer responsible for installation.
- 2.) Do not scale drawing.
- 3.) Bench detail shown with embedded and surface mounted options for clarity. Mounting not manufactured as depicted.
- 4.) 6'-0" bench, with round bar seat pan, and armrests shown.

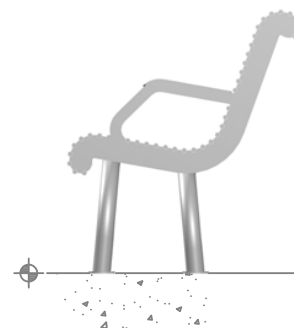

WITH ARMREST

OPTION 'D'

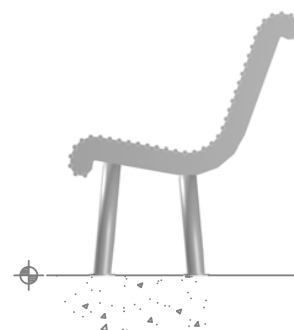

WITHOUT ARMREST

OPTION 'D'

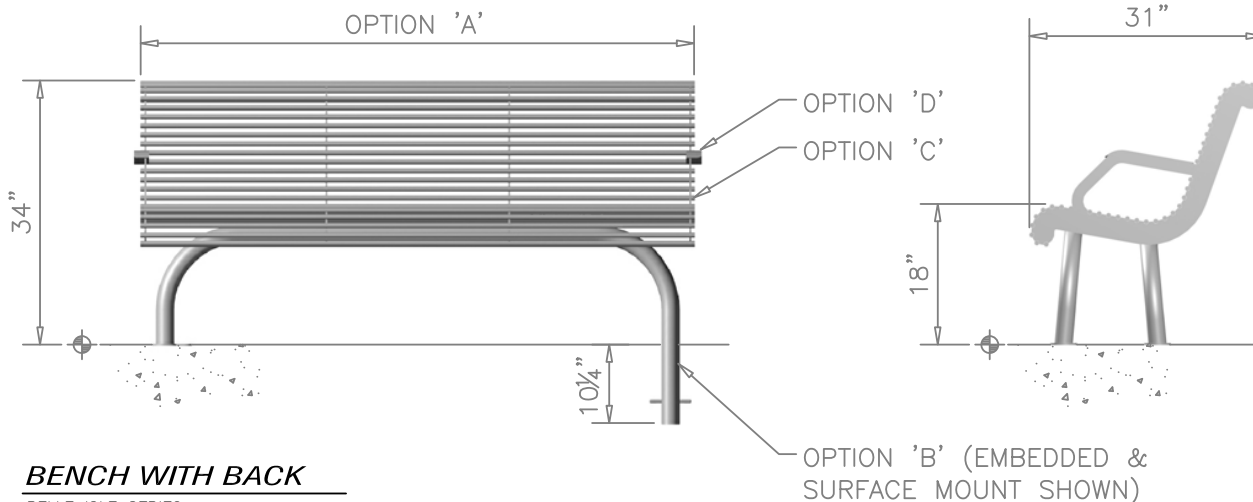

BENCH WITH BACK

BELLE ISLE SERIES

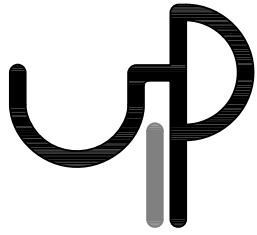

49 Life Sciences Parkway • Steinbach, MB R5G 2G7
Phone: 1-800-775-0018 • (204) 320-1801
Fax: (204) 346-1450
Email: info@urbanpark.com
Visit Us At: www.urbanpark.com

urban park

SPECIFICATION SHEET

Belle Isle Series Bench with Back

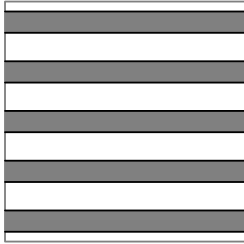

Flat Bar

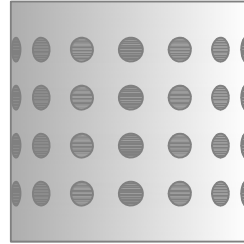

Embossed

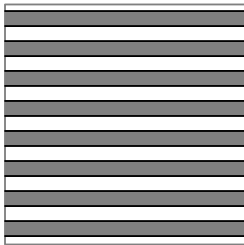

Round Bar



Perforated Mesh

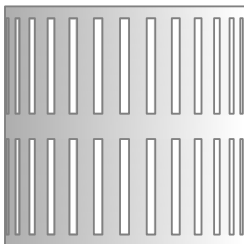

Vertical Slot



Solid

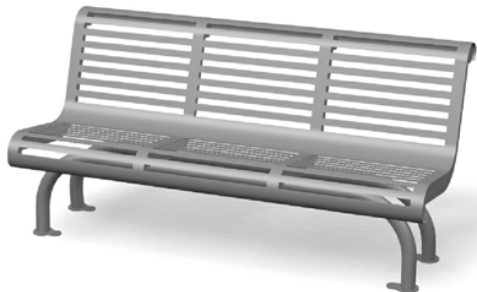

Horizontal Slot



Custom