

49 Life Sciences Parkway • Steinbach, MB R5G 2G7  
Phone: 1-800-775-0018 • (204) 320-1801  
Fax: (204) 346-1450  
Email: info@urbanpark.com  
Visit Us At: www.urbanpark.com

**urban park**

## SPECIFICATION SHEET

### Green Acres Series Picnic Table

OPTION 'A' (Length)

- 4'-0"
- 6'-0"

OPTION 'B' (Mounting)

- Surface Mounted
- Free Standing

OPTION 'C' (Seat Pan & Table Top)

See Attached Page

OPTION 'D' (Finish)

- Galvanized
- Powder Coat (includes Autophoretic Coating)
- Stainless Steel # 4 Polish

General Notes:

- 1.) Customer responsible for installation.
- 2.) Do not scale drawing.
- 3.) 6'-0" picnic table shown.

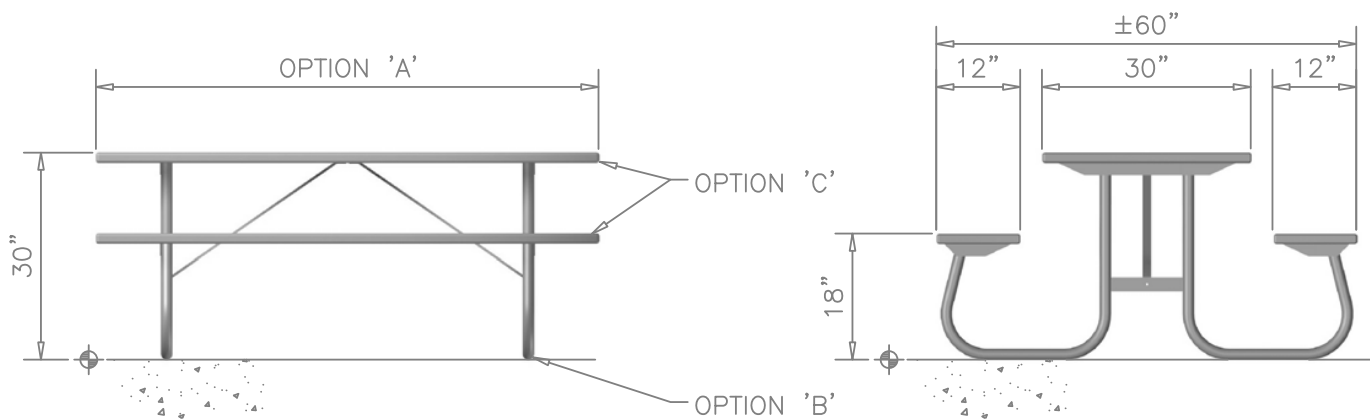

**PICNIC TABLE**

GREEN ACRES SERIES

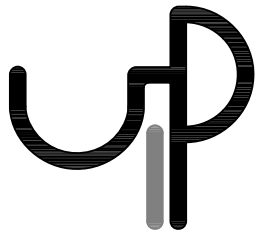

49 Life Sciences Parkway • Steinbach, MB R5G 2G7  
Phone: 1-800-775-0018 • (204) 320-1801  
Fax: (204) 346-1450  
Email: [info@urbanpark.com](mailto:info@urbanpark.com)  
Visit Us At: [www.urbanpark.com](http://www.urbanpark.com)

**urban park**

## SPECIFICATION SHEET

### Green Acres Series Picnic Table

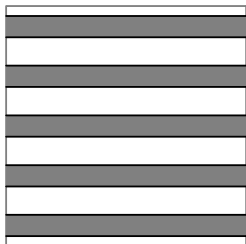

Flat Bar

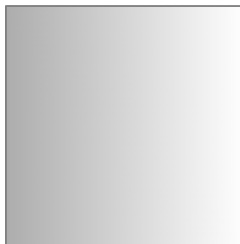

Solid

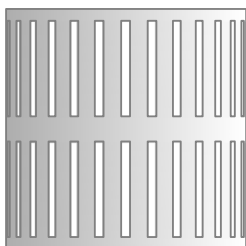

Vertical Slot



Wood

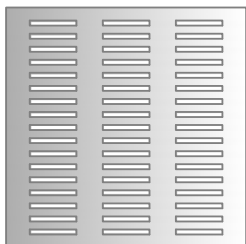

Horizontal Slot



Recycled Plastic

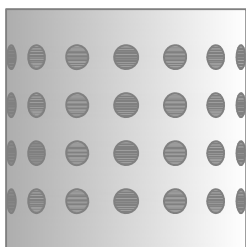

Embossed



Custom



Perforated Mesh