

49 Life Sciences Parkway • Steinbach, MB R5G 2G7
 Phone: 1-800-775-0018 • (204) 320-1801
 Fax: (204) 346-1450
 Email: info@urbanpark.com
 Visit Us At: www.urbanpark.com

urban park

SPECIFICATION SHEET

Jackson Series Picnic Table

OPTION 'A' (Seats)

See Attached Page

OPTION 'B' (Mounting)

- Embedded
- Surface Mount

OPTION 'C' (Seating)

- Attached Bench
- Detached Bench

OPTION 'D' (Seat Pan & Table Top)

See Attached Page

OPTION 'E' (Finish)

- Galvanized
- Powder Coat (includes Autophoretic Coating)
- Stainless Steel # 4 Polish

General Notes:

- 1.) Customer responsible for installation.
- 2.) Do not scale drawing.
- 3.) 2 seater picnic table, surface mounted, attached seating with perforated mesh seat pan and table top shown.

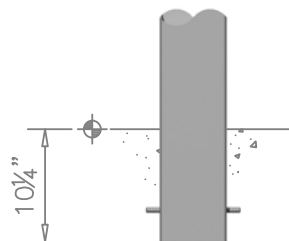

EMBEDDED

OPTION 'B'

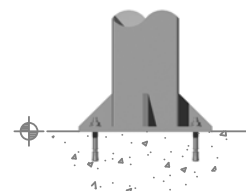

SURFACE MOUNT

OPTION 'B'

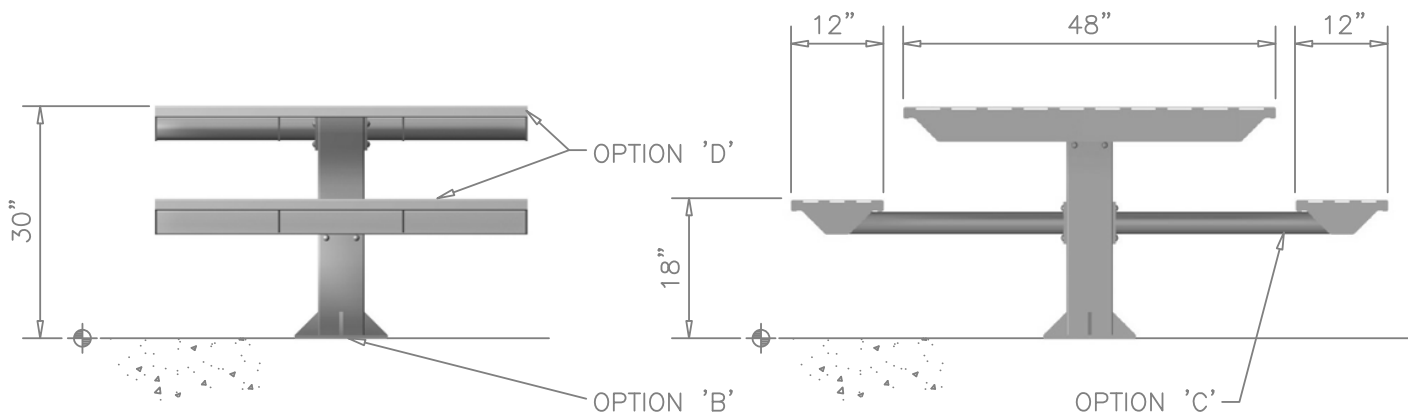

PICNIC TABLE

JACKSON SERIES

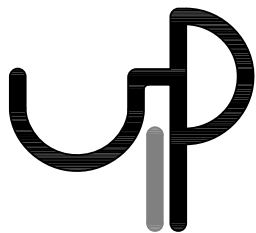

49 Life Sciences Parkway • Steinbach, MB R5G 2G7
Phone: 1-800-775-0018 • (204) 320-1801
Fax: (204) 346-1450
Email: info@urbanpark.com
Visit Us At: www.urbanpark.com

urban park

SPECIFICATION SHEET

Jackson Series Picnic Table

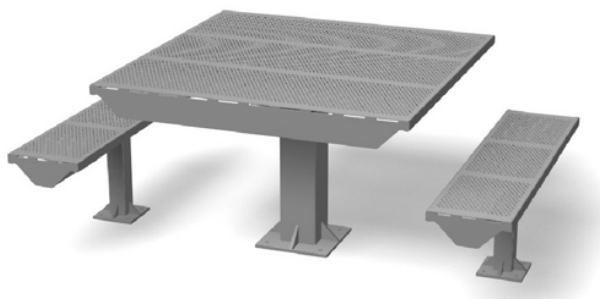

- 2 Seater
(shown with detached bench)

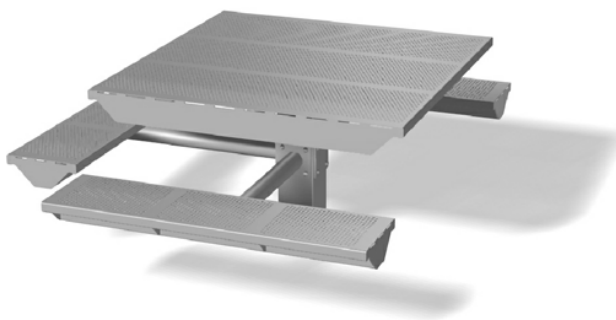

- 3 Seater
(shown with attached bench)

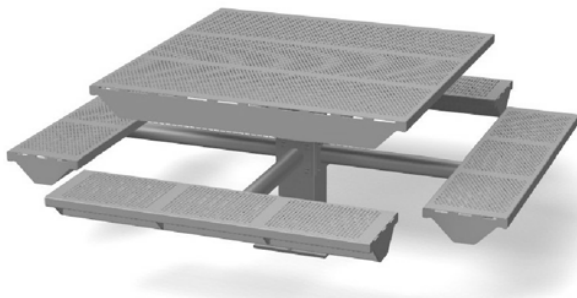

- 4 Seater
(shown with attached bench)

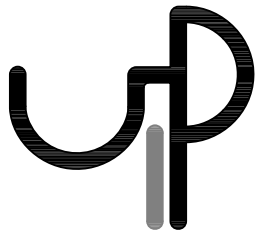

49 Life Sciences Parkway • Steinbach, MB R5G 2G7
Phone: 1-800-775-0018 • (204) 320-1801
Fax: (204) 346-1450
Email: info@urbanpark.com
Visit Us At: www.urbanpark.com

urban park

SPECIFICATION SHEET

Jackson Series Picnic Table

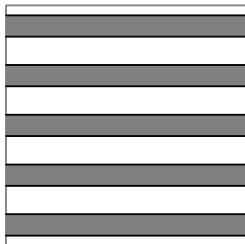

Flat Bar



Round Bar

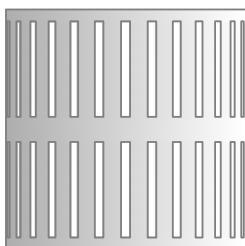

Vertical Slot

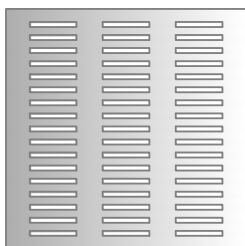

Horizontal Slot

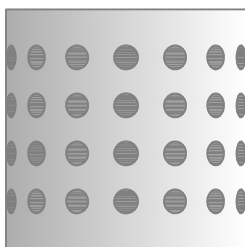

Embossed

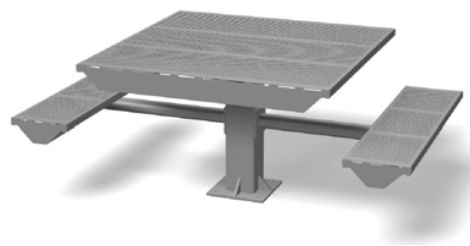

Perforated Mesh

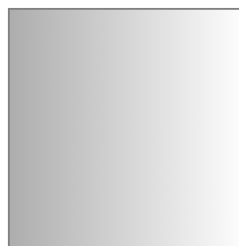

Solid



Wood



Recycled Plastic



Custom