

49 Life Sciences Parkway • Steinbach, MB R5G 2G7
 Phone: 1-800-775-0018 • (204) 320-1801
 Fax: (204) 346-1450
 Email: info@urbanpark.com
 Visit Us At: www.urbanpark.com

urban park

SPECIFICATION SHEET

Terressa Series Picnic Table

OPTION 'A' (Chairs)

- 2 Chairs
- 3 Chairs
- 4 Chairs

OPTION 'B' (Seat Pan)

See Attached Page

OPTION 'C' (Table Top)

See Attached Page

OPTION 'D' (Armrest)

- With Arm
- Without Arm

OPTION 'E' (Finish)

- Galvanized
- Powder Coat (includes Autophoretic Coating)
- Stainless Steel # 4 Polish

General Notes:

- 1.) Customer responsible for installation.
- 2.) Do not scale drawing.
- 3.) 4 chair picnic table, surface mounted with perforated mesh seat pan and table top shown.

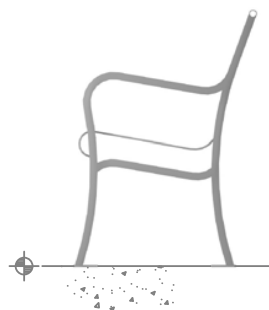

WITH ARMREST

OPTION 'D'

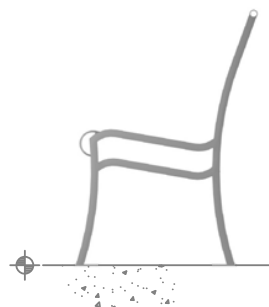

WITHOUT ARMREST

OPTION 'D'

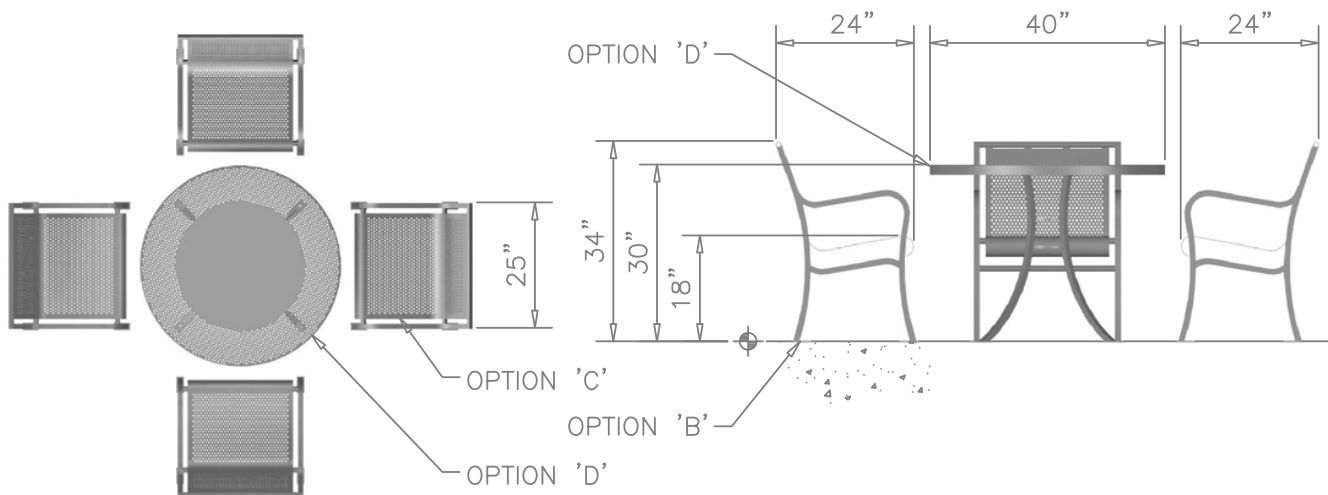

PICNIC TABLE

TERRESSA SERIES

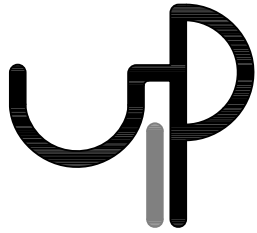

49 Life Sciences Parkway • Steinbach, MB R5G 2G7
Phone: 1-800-775-0018 • (204) 320-1801
Fax: (204) 346-1450
Email: info@urbanpark.com
Visit Us At: www.urbanpark.com

urban park

SPECIFICATION SHEET

Terressa Series Picnic Table



Flat Bar

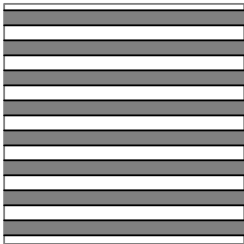

Round Bar

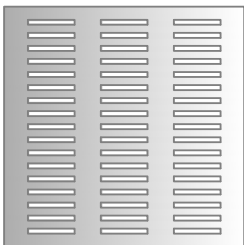

Vertical Slot

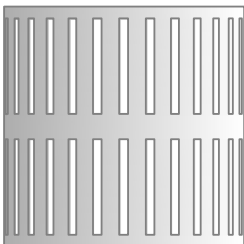

Horizontal Slot

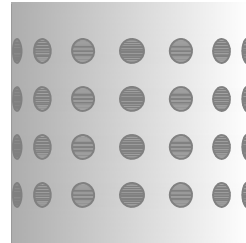

Embossed



Perforated Mesh

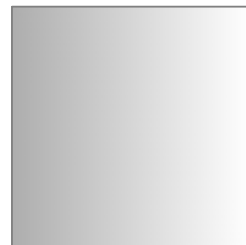

Solid



Custom